

# Cable resistance thermometer Mineral-insulated cable (MI cable) Model TR40

WIKA data sheet TE 60.40



for further approvals  
see page 2

## Applications

- For direct installation into the process
- Machine building
- Motors
- Bearings
- Pipes and vessels

## Special features

- Sensor ranges from -196 ... +600 °C [-320 ... +1,112 °F]
- For insertion or screw-in with optional process connection
- Cable from PTFE, PFA, silicone and other cable sheath materials
- Versions with/without connector or connection housing (option)
- Explosion-protected versions are available for many approval types (see page 2)

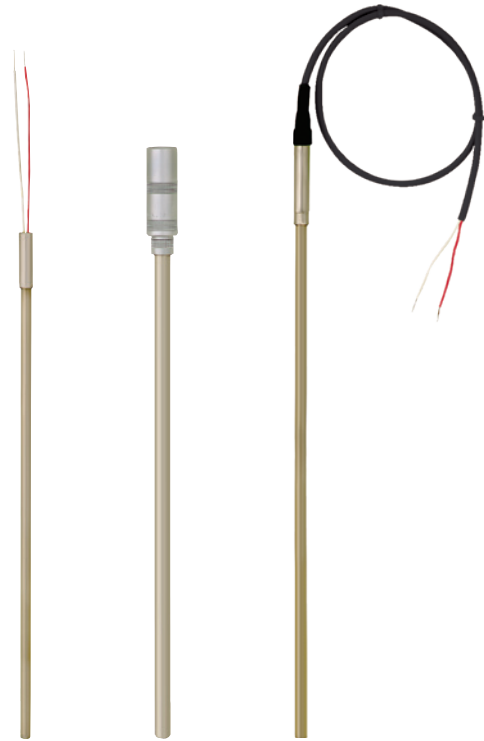

Cable resistance thermometer, model TR40

## Description

Cable resistance thermometers are particularly suited to those applications in which the metallic probe tip is mounted directly into bored holes (e.g. in machine components) or directly into the process for any application with no chemically aggressive media or abrasion.

A large number of different explosion protection approvals are available for the TR40.

For mounting into a thermowell, a spring-loaded compression fitting should be provided, since only this can press the measuring tip into the bottom of the thermowell. Otherwise a potentially critical force could be exerted on the measuring tip.

In the standard version the cable probes are manufactured without process connections. Fastening elements such as threaded connections, compression fittings, etc. are possible as options.







## Explosion protection (option)









The permissible power,  $P_{max}$ , as well as the permissible ambient temperature, for the respective category can be seen on the certificate for hazardous areas or in the operating instructions.

Transmitters have own certificates for hazardous areas. The permissible ambient temperature ranges of the built-in transmitters can be taken from the corresponding transmitter operating instructions and approvals.

The internal inductance ( $L_i = 1 \mu\text{H/m}$ ) and capacitance ( $C_i = 200 \text{ pF/m}$ ) for cable probes should be taken into account when connecting to an intrinsically safe voltage supply.

## Approvals (explosion protection, further approvals)

Logo	Description	Country
 	<b>EU declaration of conformity</b> <ul style="list-style-type: none"> <li>■ EMC directive <sup>1)</sup> EN 61326 emission (group 1, class B) and immunity (industrial application)</li> <li>■ RoHS directive</li> <li>■ ATEX directive (option) Hazardous areas           <ul style="list-style-type: none"> <li>- Ex i Zone 0 gas II 1G Ex ia IIC T1 ... T6 Ga</li> <li>Zone 1 mounting to zone 0 gas II 1/2G Ex ia IIC T1 ... T6 Ga/Gb</li> <li>Zone 1 gas II 2G Ex ia IIC T1 ... T6 Gb</li> <li>Zone 20 dust II 1D Ex ia IIIC T125 ... T65 °C Da</li> <li>Zone 21 mounting to zone 20 dust II 1/2D Ex ia IIIC T125 ... T65 °C Da/Db</li> <li>Zone 21 dust II 2D Ex ia IIIC T125 ... T65 °C Db</li> <li>- Ex e <sup>2)</sup> Zone 1 gas II 2G Ex eb IIC T1 ... T6 Gb <sup>4)</sup></li> <li>Zone 2 gas II 3G Ex ec IIC T1 ... T6 Gc X</li> <li>Zone 21 dust II 2D Ex tb IIIC TX °C Db <sup>4)</sup></li> <li>Zone 22 dust II 3D Ex tc IIIC TX °C Dc X</li> <li>- Ex n <sup>2)</sup> Zone 2 gas II 3G Ex nA IIC T1 ... T6 Gc X</li> <li>Zone 22 dust II 3D Ex tc IIIC TX °C Dc X</li> </ul> </li> </ul>	European Union
 	<b>IECEx (option) - in conjunction with ATEX</b> Hazardous areas <ul style="list-style-type: none"> <li>- Ex i Zone 0 gas Ex ia IIC T1 ... T6 Ga</li> <li>Zone 1 mounting to zone 0 gas Ex ia IIC T1 ... T6 Ga/Gb</li> <li>Zone 1 gas Ex ia IIC T1 ... T6 Gb</li> <li>Zone 20 dust Ex ia IIIC T125 ... T65 °C Da</li> <li>Zone 21 mounting to zone 20 dust Ex ia IIIC T125 ... T65 °C Da/Db</li> <li>Zone 21 dust Ex ia IIIC T125 ... T65 °C Db</li> <li>- Ex e <sup>3)</sup> Zone 1 gas Ex eb IIC T1...T6 Gb <sup>4)</sup></li> <li>Zone 2 gas Ex ec IIC T1...T6 Gc</li> <li>Zone 21 dust Ex tb IIIC TX °C Db <sup>4)</sup></li> <li>Zone 22 dust Ex tc IIIC TX °C Dc</li> <li>- Ex n <sup>3)</sup> Zone 2 gas Ex nA IIC T1...T6 Gc</li> <li>Zone 22 dust Ex tc IIIC TX °C Dc</li> </ul>	International
	<b>EAC (option)</b> Hazardous areas <ul style="list-style-type: none"> <li>- Ex i Zone 0 gas 0Ex ia IIC T6 ... T1 Ga X</li> <li>Zone 1 gas 1Ex ia IIC T6 ... T1 Gb X</li> <li>Zone 20 dust Ex ia IIIC T80...T440 °C Da X</li> <li>Zone 21 dust Ex ia IIIC T80...T440 °C Db X</li> <li>- Ex n Zone 2 gas 2Ex nA IIC T6 ... T1 Gc X</li> </ul>	Eurasian Economic Community
	<b>Ex Ukraine (option)</b> Hazardous areas <ul style="list-style-type: none"> <li>- Ex i Zone 0 gas II 1G Ex ia IIC T1 ... T6 Ga</li> <li>Zone 1 mounting to zone 0 gas II 1/2G Ex ia IIC T1 ... T6 Ga/Gb</li> <li>Zone 1 gas II 2G Ex ia IIC T1 ... T6 Gb</li> <li>Zone 20 dust II 1D Ex ia IIIC T65 °C Da</li> <li>Zone 21 mounting to zone 20 dust II 1/2D Ex ia IIIC T65 °C Da/Db</li> <li>Zone 21 dust II 2D Ex ia IIIC T65 °C Db</li> </ul>	Ukraine

Logo	Description	Country
	<b>INMETRO (option)</b> Hazardous areas - Ex i Zone 0 gas Ex ia IIC T3 ... T6 Ga Zone 1 mounting to zone 0 gas Ex ia IIC T3 ... T6 Ga/Gb Zone 20 dust Ex ia IIIC T125 ... T65 °C Da Zone 21 mounting to zone 20 dust Ex ia IIIC T125 ... T65 °C Da/Db	Brazil
	<b>CCC (option) 4)</b> Hazardous areas - Ex i Zone 0 gas Ex ia IIC T1 ~ T6 Ga Zone 1 gas Ex ia IIC T1 ~ T6 Gb Zone 1 mounting to zone 0 gas Ex ia IIC T1 ~ T6 Ga/Gb Zone 2 gas Ex ic IIC T1 ~ T6 Gc Zone 20 dust Ex iaD 20 T65/T95/T125 °C Zone 21 dust Ex iaD 21 T65/T95/T125 °C Zone 21 mounting to zone 20 dust Ex iaD 20/21 T65/T95/T125 °C - Ex e 3) Zone 1 gas Ex eb IIC T1 ~ T6 Gb 4) Zone 2 gas Ex ec IIC T1 ~ T6 Gc - Ex n Zone 2 gas Ex nA IIC T1 ~ T6 Gc	China
	<b>KCs - KOSHA (option)</b> Hazardous areas - Ex i Zone 0 gas Ex ia IIC T4 ... T6 Zone 1 gas Ex ib IIC T4 ... T6	South Korea
-	<b>PESO (option)</b> Hazardous areas - Ex i Zone 0 gas Ex ia IIC T1 ... T6 Ga Zone 1 mounting to zone 0 gas Ex ia IIC T1 ... T6 Ga/Gb Zone 1 gas Ex ia IIC T1 ... T6 Gb	India
	<b>GOST (option)</b> Metrology, measurement technology	Russia
	<b>KazInMetr (option)</b> Metrology, measurement technology	Kazakhstan
-	<b>MTSCHS (option)</b> Permission for commissioning	Kazakhstan
	<b>BelGIM (option)</b> Metrology, measurement technology	Belarus
	<b>UkrSEPRO (option)</b> Metrology, measurement technology	Ukraine
	<b>Uzstandard (option)</b> Metrology, measurement technology	Uzbekistan

1) Only for built-in transmitter

2) Only with connection head, model BSZ, BSZ-H, 1/4000, 5/6000 or 7/8000 (see "Connection head")

3) Only with connection head, model 1/4000, 5/6000 or 7/8000 (see "Connection head")

4) Without transmitter

## Manufacturer's information and certificates

Logo	Description
	<b>SIL 2</b> Functional safety (only in conjunction with model T32 temperature transmitter)

Instruments marked with "ia" may also be used in areas only requiring instruments marked with "ib" or "ic".

If an instrument with "ia" marking has been used in an area with requirements in accordance with "ib" or "ic", it can no longer be operated in areas with requirements in accordance with "ia" afterwards.

Approvals and certificates, see website

# Sensor

## Measuring element

Pt100, Pt1000 <sup>1)</sup> (measuring current: 0.1 ... 1.0 mA) <sup>2)</sup>

Connection method	
Single element	1 x 2-wire 1 x 3-wire 1 x 4-wire
Dual elements	2 x 2-wire 2 x 3-wire 2 x 4-wire <sup>3)</sup>

Validity limits of the class accuracy in accordance with EN 60751		
Class	Sensor construction	
	Wire-wound	Thin-film
Class B	-196 ... +600 °C -196 ... +450 °C	-50 ... +500 °C -50 ... +250 °C
Class A <sup>4)</sup>	-100 ... +450 °C	-30 ... +300 °C
Class AA <sup>4)</sup>	-50 ... +250 °C	0 ... 150 °C

1) Pt1000 only available as a thin-film measuring resistor

2) For detailed specifications for Pt100 sensors, see Technical information IN 00.17 at [www.wika.com](http://www.wika.com).

3) Not with 3 mm diameter

4) Not with 2-wire connection method

- The combinations of a 2-wire connection with class A or class AA are not permissible, since the lead resistance of the MI cable and the connection lead negates the higher sensor accuracy.
- When using a 3-wire connection, we recommend not to exceed a probe length, including the connection cable, of approx. 30 m.
- Longer probe/cable lengths should be designed with a 4-wire connection.

The TR40 can be operated, under certain conditions, in a temperature range outside the temperature range of the specified class. With respect to compliance with the limiting deviation (class accuracy), however, the following must be observed: With standard instruments, the previously specified class can no longer be confirmed if the thermometer was operated above or below the corresponding class temperature range. The dwell time is not relevant here. Even if the temperature is in the range of the selected class again, the class accuracy of the measuring resistor is no longer defined.

Operation outside the measuring range defined for the given class and design can result in permanent damage to the measuring resistor.

## Minimum and maximum operating temperature

### Process temperature

The process temperature is the temperature which prevails in the area between the probe tip and the process connection. This generally corresponds to the temperatures for which the resistance thermometer has been defined in accordance with IEC 60751 standard.

Short insertion lengths and specific components can limit the operating temperature of the thermometer (e.g. PTFE ferrules on a compression fitting, sealing compound in the probe tip).

### Ambient temperature

The area of the transition from MI cable to connection cable (see page 12) and all subsequent components are located in the region of ambient temperature.

If the ambient temperature is higher than the permissible temperature at the cable, connector or transition, the metallic part of the probe must be long enough so that the transition is located outside of the hot zone. At any point on the connection cable, the maximum temperature that may be attained is that for which the connection cable is specified. The probe itself can – within the validity limits of its class accuracy – be loaded higher.

It is important to ensure that the lowest of the maximum permissible ambient temperatures for connection cables, materials used such as sealing compounds in the transition sleeve or a fitted connector or case is not exceeded.

- Maximum temperature at connection housing: 80 °C
- Maximum temperature at connector: 80 °C
- Maximum temperature of the sealing compound at the transition: 250 °C
- Maximum temperature of vibration-resistant versions: 200 °C
- In an optional approval minimum and maximum temperature specified

Other variants on request

For information on the maximum permissible operating temperatures for the connection cable see page 13.

The limits of the permissible ambient temperature are, with special low-temperature versions, extended in the lower temperature range to -60 °C. The maximum temperature of these instrument versions is +120 °C.

The use of thermometers with low temperatures in explosion-protected areas is only available with selected approvals.

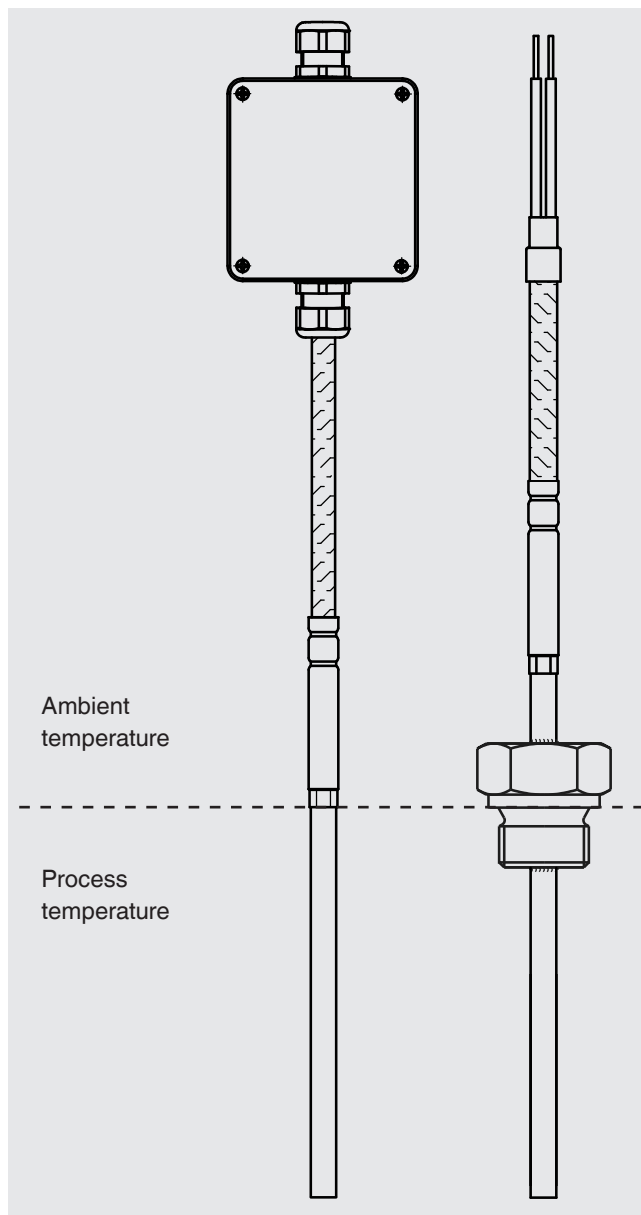

## General design of the TR40

In sheathed resistance thermometers the flexible part of the probe consists of a mineral-insulated cable (MI cable). It features a stainless steel outer sheath, which contains the insulated internal leads, embedded within a high-density ceramic compound.

The measuring resistor is connected directly to the internal leads of the sheathed cable and is, therefore, also suitable for use at higher temperatures.

Due to their flexibility and the small possible diameters, sheathed resistance thermometers can also be used in locations that are not easily accessible, since, with the exception of the probe tip and the transition sleeve of the connection cable, the sheath can be bent to a radius of five times the diameter of the cable. The first 60 mm of the probe tip must not be bent.

Please note:

The flexibility of the sheathed resistance thermometer must be considered, especially when the flow rates are relatively high.

For temperature measurement in a solid body, the diameter of the bore into which the probe should be inserted, should be no more than 1 mm larger than the probe diameter. Each air gap acts as an insulation layer.



Mineral-insulated cable (MI cable)



Sensor in the probe tip

# Versions

## ■ With connection cable

Standard version

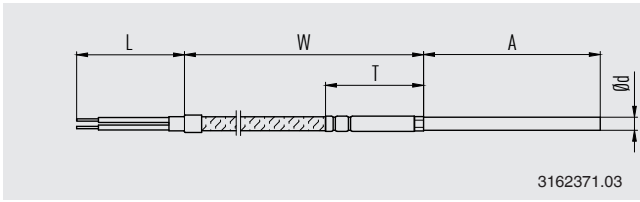

Single wires

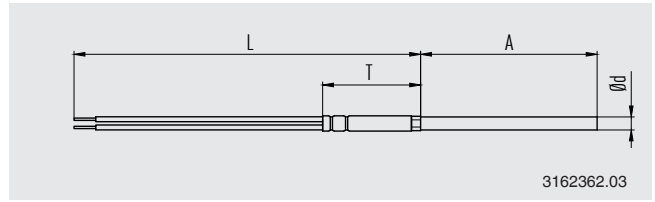

Connection cable with stainless steel braid

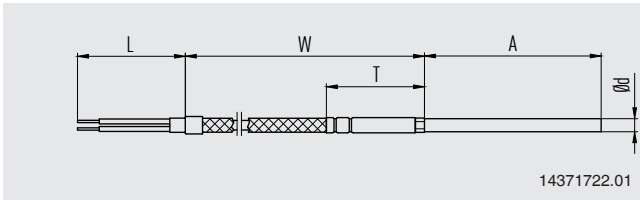

Connection cable with protective metal armouring

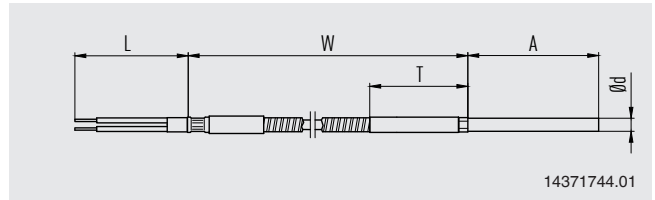

## ■ With connector

Fitted on the MI cable

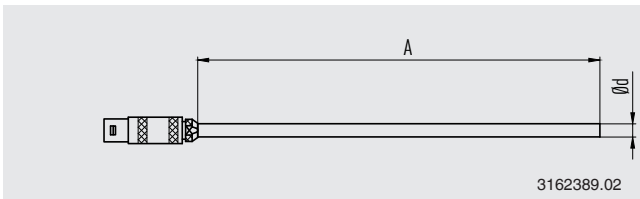

Fitted to the cable end

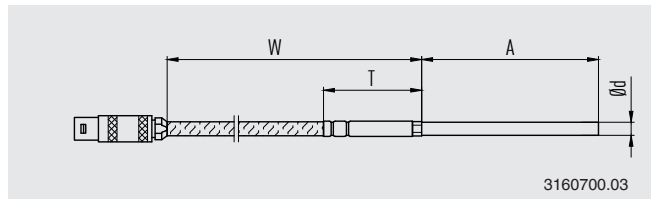

For all ignition protection types except Ex i, gas applies:  
Position of the connector is only permitted outside the hazardous area.

## ■ With connection housing fitted at the cable end

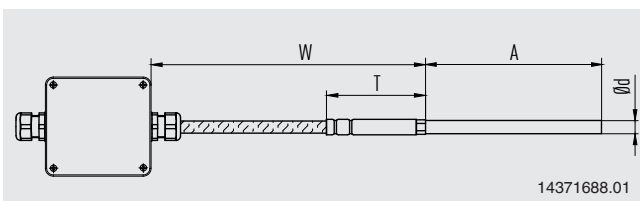

## Angled probes

TR40 cable resistance thermometers can be delivered in a pre-formed shape. In this case, the position of the bend is defined by a further dimension.

Using a fixed threaded connection is not recommended, as the angled probe would need to be screwed into the process with a wide sweeping movement.

Legend:

- X Distance of the bend to the end of the tube
- A Insertion length of the probe (section which is built into the process)
- Y Distance from the centre of the bend to the measurement plane of the threaded connection (only if a threaded connection is used)

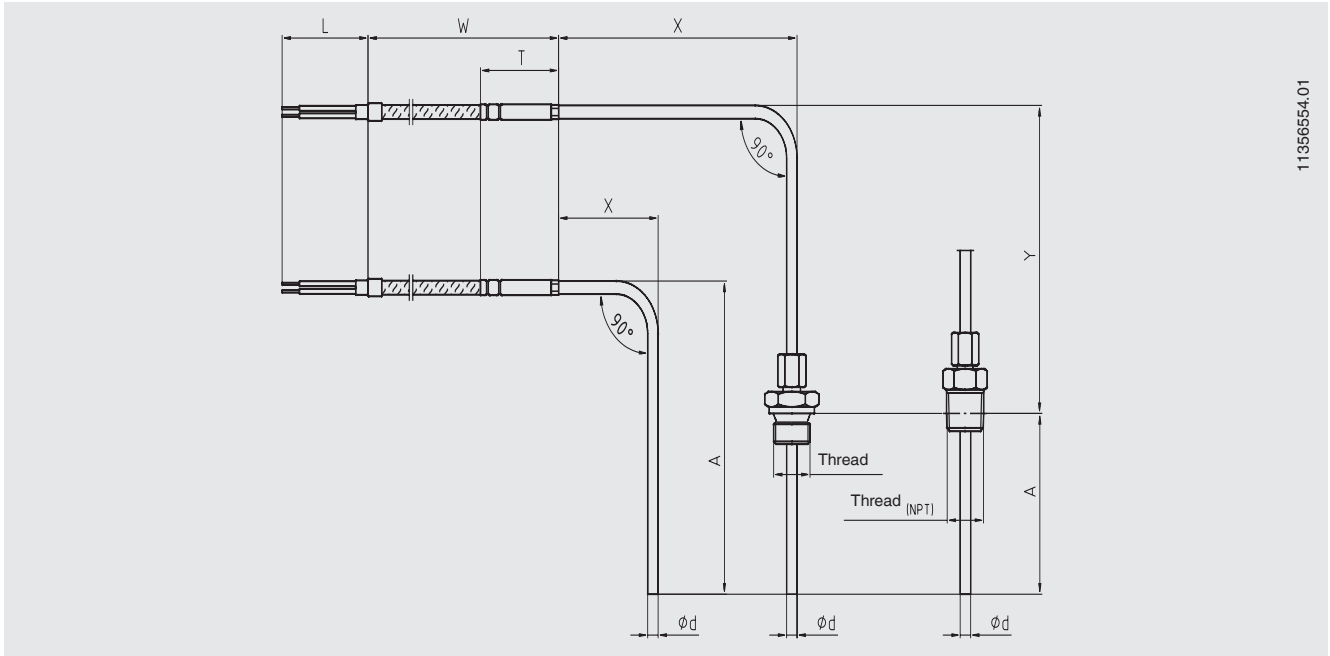

1135654.01

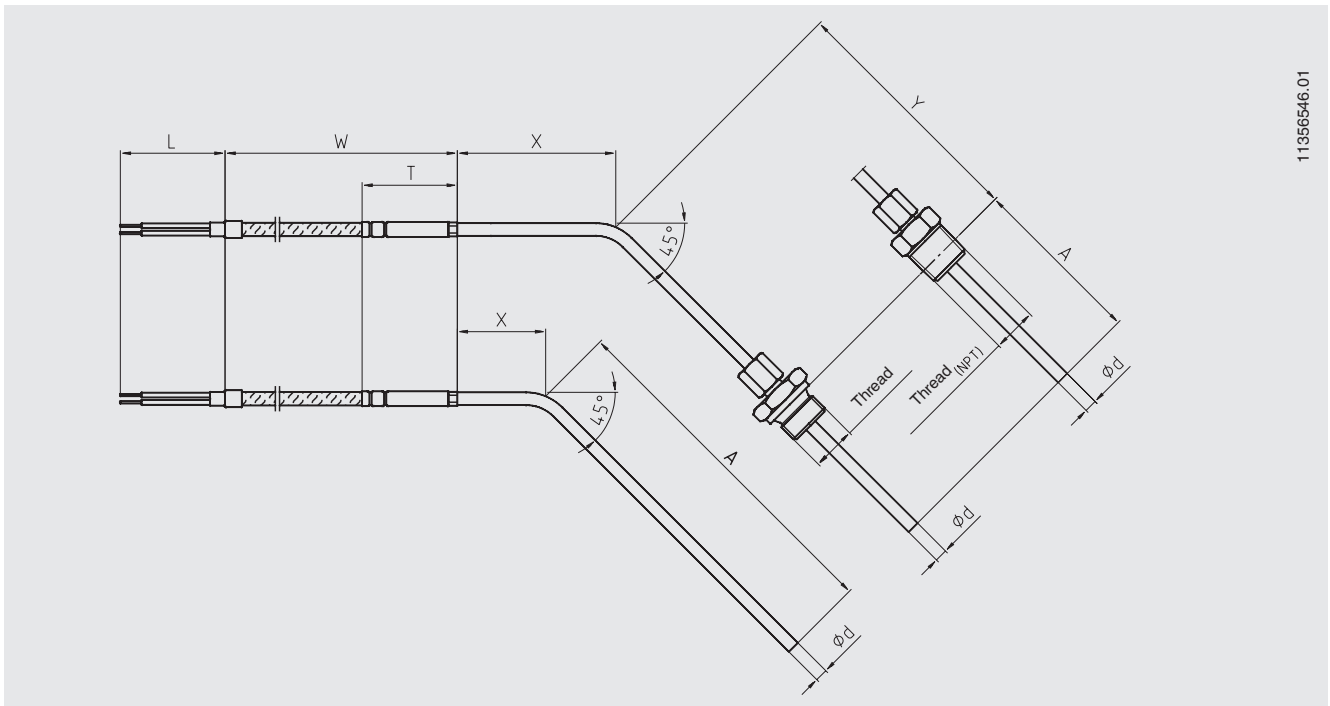

11356546.01



## Process connection

TR40 cable resistance thermometers can be fitted with an optional process connection.

To minimise heat dissipation errors via the threaded connection, the insertion length, A, should be at least 25 mm long.

Please note:

- For parallel threads (e.g. G 1/2) the dimensioning always refers to the sealing collar of the threaded connection nearest the process
- For tapered threads (e.g. NPT) the measurement plane is located approx. in the centre of the thread

Legend:

- X Position of the threaded connection (independent of the type of connection)
- A Insertion length in the process

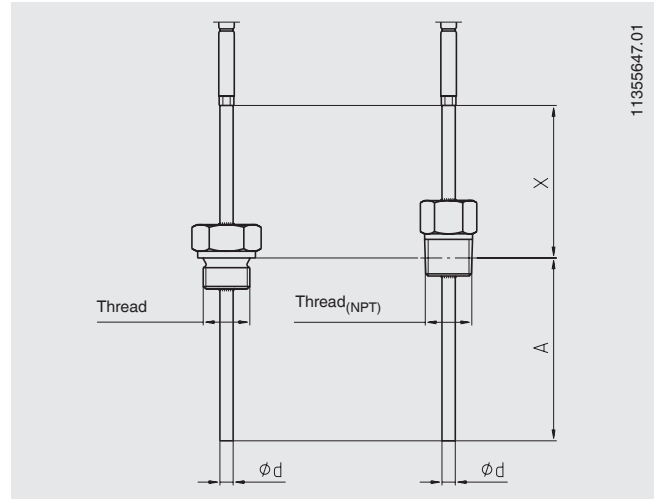

## International designs

### ■ Without process connection

Smooth probe for insertion

Design	Illustration	Material process connection	Thread size	Diameter sheathed cable	Material sheathed cable
Without process connection		-	-	<ul style="list-style-type: none"> <li>■ 3 mm</li> <li>■ 6 mm</li> <li>■ 8 mm</li> <li>■ 1/8 in/0.125 in [3.17 mm]</li> <li>■ 1/4 in/0.250 in [6.35 mm]</li> <li>■ 3/8 in/0.375 in [9.53 mm]</li> </ul>	<ul style="list-style-type: none"> <li>■ Stainless steel 1.4571</li> <li>■ Stainless steel 316L</li> </ul>

### ■ Fixed threaded connection, thread

- Version to mount the probe into a threaded coupling with a female thread
- Probe must be rotated in order to screw it into the process
- Therefore, first fit the version mechanically and then connect it electrically

Design	Illustration	Material process connection	Thread size	Diameter sheathed cable	Material sheathed cable
Fixed threaded connection, thread		<ul style="list-style-type: none"> <li>■ Stainless steel 1.4571</li> <li>■ Stainless steel 316L</li> </ul>	<ul style="list-style-type: none"> <li>■ G 1/8 B</li> <li>■ 1/8 NPT</li> <li>■ M8 x 1.0</li> </ul>	<ul style="list-style-type: none"> <li>■ 3 mm</li> <li>■ 1/8 in/0.125 in [3.17 mm]</li> </ul>	<ul style="list-style-type: none"> <li>■ Stainless steel 1.4571</li> <li>■ Stainless steel 316L</li> </ul>
			<ul style="list-style-type: none"> <li>■ G 1/4 B</li> <li>■ G 3/8 B</li> <li>■ 1/4 NPT</li> <li>■ 3/8 NPT</li> <li>■ M10 x 1.0</li> </ul>	<ul style="list-style-type: none"> <li>■ 3 mm</li> <li>■ 6 mm</li> <li>■ 1/8 in/0.125 in [3.17 mm]</li> <li>■ 1/4 in/0.250 in [6.35 mm]</li> </ul>	<ul style="list-style-type: none"> <li>■ Stainless steel 1.4571</li> <li>■ Stainless steel 316L</li> </ul>
			<ul style="list-style-type: none"> <li>■ G 1/2 B</li> <li>■ G 3/4 B</li> <li>■ 1/2 NPT</li> <li>■ 3/4 NPT</li> <li>■ M12 x 1.5</li> <li>■ M14 x 1.5</li> <li>■ M16 x 1.5</li> <li>■ M18 x 1.5</li> <li>■ M20 x 1.5</li> </ul>	<ul style="list-style-type: none"> <li>■ 3 mm</li> <li>■ 6 mm</li> <li>■ 8 mm</li> <li>■ 1/8 in/0.125 in [3.17 mm]</li> <li>■ 1/4 in/0.250 in [6.35 mm]</li> <li>■ 3/8 in/0.375 in [9.53 mm]</li> </ul>	<ul style="list-style-type: none"> <li>■ Stainless steel 1.4571</li> <li>■ Stainless steel 316L</li> </ul>

■ **Compression fitting with stainless steel ferrule**

- Simple adjustment at the mounting point to the desired insertion length
- Compression fitting can be slid along the probe (only for the first tightening)
- After loosening, sliding along the sheath is no longer possible
- Dimensions A and X describe the as-delivered condition
- Smallest possible length X of approx. 50 mm (due to the length of the compression fitting)
- Max. temperature at the process connection: 500 °C (unpressurised)
- Max. pressure loading: 20 bar (at max. 150 °C, Ø 6 mm)

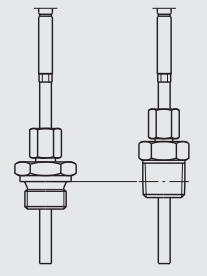
Design	Illustration	Material process connection	Thread size	Diameter sheathed cable	Material sheathed cable
<b>Compression fitting with stainless steel ferrule</b>		<ul style="list-style-type: none"> <li>■ Stainless steel 1.4571</li> <li>■ Stainless steel 316L</li> </ul>	<ul style="list-style-type: none"> <li>■ G 1/8 B</li> <li>■ 1/8 NPT</li> <li>■ M8 x 1.0</li> </ul>	<ul style="list-style-type: none"> <li>■ 3 mm</li> <li>■ 1/8 in/0.125 in [3.17 mm]</li> </ul>	<ul style="list-style-type: none"> <li>■ Stainless steel 1.4571</li> <li>■ Stainless steel 316L</li> </ul>
			<ul style="list-style-type: none"> <li>■ G 1/4 B</li> <li>■ G 3/8 B</li> <li>■ 1/4 NPT</li> <li>■ 3/8 NPT</li> <li>■ M10 x 1.0</li> </ul>	<ul style="list-style-type: none"> <li>■ 3 mm</li> <li>■ 6 mm</li> <li>■ 1/8 in/0.125 in [3.17 mm]</li> <li>■ 1/4 in/0.250 in [6.35 mm]</li> </ul>	<ul style="list-style-type: none"> <li>■ Stainless steel 1.4571</li> <li>■ Stainless steel 316L</li> </ul>
			<ul style="list-style-type: none"> <li>■ G 1/2 B</li> <li>■ G 3/4 B</li> <li>■ 1/2 NPT</li> <li>■ 3/4 NPT</li> <li>■ M12 x 1.5</li> <li>■ M14 x 1.5</li> <li>■ M16 x 1.5</li> <li>■ M18 x 1.5</li> <li>■ M20 x 1.5</li> </ul>	<ul style="list-style-type: none"> <li>■ 3 mm</li> <li>■ 6 mm</li> <li>■ 8 mm</li> <li>■ 1/8 in/0.125 in [3.17 mm]</li> <li>■ 1/4 in/0.250 in [6.35 mm]</li> <li>■ 3/8 in/0.375 in [9.53 mm]</li> </ul>	<ul style="list-style-type: none"> <li>■ Stainless steel 1.4571</li> <li>■ Stainless steel 316L</li> </ul>

■ **Compression fitting with PTFE ferrule**

- Basic construction as for the version with stainless steel ferrule
- Ferrules can be set several times
- After loosening, sliding along the sheath is still possible
- Max. temperature at process connection: 150 °C
- For use without pressure

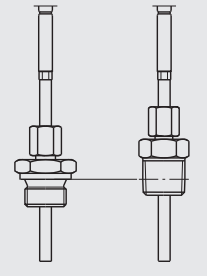

Design	Illustration	Material process connection	Thread size	Diameter sheathed cable	Material sheathed cable
<b>Compression fitting with PTFE ferrule</b>		<ul style="list-style-type: none"> <li>■ Stainless steel 1.4571</li> <li>■ Stainless steel 316L</li> </ul>	<ul style="list-style-type: none"> <li>■ G 1/8 B</li> <li>■ 1/8 NPT</li> <li>■ M8 x 1.0</li> </ul>	<ul style="list-style-type: none"> <li>■ 3 mm</li> <li>■ 1/8 in/0.125 in [3.17 mm]</li> </ul>	<ul style="list-style-type: none"> <li>■ Stainless steel 1.4571</li> <li>■ Stainless steel 316L</li> </ul>
			<ul style="list-style-type: none"> <li>■ G 1/4 B</li> <li>■ G 3/8 B</li> <li>■ 1/4 NPT</li> <li>■ 3/8 NPT</li> <li>■ M10 x 1.0</li> </ul>	<ul style="list-style-type: none"> <li>■ 3 mm</li> <li>■ 6 mm</li> <li>■ 1/8 in/0.125 in [3.17 mm]</li> <li>■ 1/4 in/0.250 in [6.35 mm]</li> </ul>	<ul style="list-style-type: none"> <li>■ Stainless steel 1.4571</li> <li>■ Stainless steel 316L</li> </ul>
			<ul style="list-style-type: none"> <li>■ G 1/2 B</li> <li>■ G 3/4 B</li> <li>■ 1/2 NPT</li> <li>■ 3/4 NPT</li> <li>■ M12 x 1.5</li> <li>■ M14 x 1.5</li> <li>■ M16 x 1.5</li> <li>■ M18 x 1.5</li> <li>■ M20 x 1.5</li> </ul>	<ul style="list-style-type: none"> <li>■ 3 mm</li> <li>■ 6 mm</li> <li>■ 8 mm</li> <li>■ 1/8 in/0.125 in [3.17 mm]</li> <li>■ 1/4 in/0.250 in [6.35 mm]</li> <li>■ 3/8 in/0.375 in [9.53 mm]</li> </ul>	<ul style="list-style-type: none"> <li>■ Stainless steel 1.4571</li> <li>■ Stainless steel 316L</li> </ul>

■ **Spring-loaded compression fitting with stainless steel ferrule**

- Easy adjustment to the desired insertion length at the mounting point, while at the same time maintaining the spring pre-tension
- Compression fitting can be slid along the probe (only for the first tightening)
- After loosening, sliding along the sheath is no longer possible
- Dimensions A and X describe the as-delivered condition
- Smallest possible length X of approx. 100 mm (due to the length of the compression fitting)
- Max. temperature at process connection: 150 °C
- For use without pressure
- Hydraulic-oil tight versions on request

Design	Illustration	Material process connection	Thread size	Diameter sheathed cable	Material sheathed cable
Spring-loaded compression fitting with stainless steel ferrule		<ul style="list-style-type: none"> <li>■ Stainless steel 1.4571</li> <li>■ Stainless steel 316L</li> </ul>	<ul style="list-style-type: none"> <li>■ G 1/4 B</li> <li>■ G 3/8 B</li> <li>■ G 1/2 B</li> <li>■ G 3/4 B</li> <li>■ 1/4 NPT</li> <li>■ 3/8 NPT</li> <li>■ 1/2 NPT</li> <li>■ 3/4 NPT</li> <li>■ M10 x 1.0</li> <li>■ M12 x 1.5</li> <li>■ M14 x 1.5</li> <li>■ M16 x 1.5</li> <li>■ M18 x 1.5</li> <li>■ M20 x 1.5</li> </ul>	6 mm	<ul style="list-style-type: none"> <li>■ Stainless steel 1.4571</li> <li>■ Stainless steel 316L</li> </ul>

**US design**

Design	Illustration	Material process connection	Thread size	Diameter sheathed cable	Material sheathed cable
Spring-loaded threaded connection (standard)		Stainless steel 316L	<ul style="list-style-type: none"> <li>■ 1/4 NPT</li> <li>■ 3/8 NPT</li> <li>■ 1/2 NPT</li> <li>■ 3/4 NPT</li> </ul>	<ul style="list-style-type: none"> <li>■ 6 mm</li> <li>■ 1/4 in/0.250 in [6.35 mm]</li> <li>■ 1/8 in/0.125 in [3.17 mm]</li> </ul>	Stainless steel 316L
Spring-loaded threaded connection with O-ring sealing (rated to 100 psi at 86 °C, hydrostatic testing in H <sub>2</sub> O)		Stainless steel 316L	<ul style="list-style-type: none"> <li>■ 1/4 NPT</li> <li>■ 3/8 NPT</li> <li>■ 1/2 NPT</li> <li>■ 3/4 NPT</li> </ul>	1/4 in/0.250 in [6.35 mm]	Stainless steel 316L
Fixed fitting/double threaded hex bushing (welded)		Stainless steel 316L	<ul style="list-style-type: none"> <li>■ 1/2 NPT</li> <li>■ 3/4 NPT</li> </ul>	1/4 in/0.250 in [6.35 mm]	Stainless steel 316L

## Transition

### Standard version

The junction between the metal part of the probe and the connection lead or stranded wire should not be immersed within the process and must not be bent. Compression fittings should not be attached to the transition sleeve.

The dimensions of the transition sleeve are dependent upon the probe diameter, on the construction of the connection cable and its number of inner conductors - depending on the connection method. Also, operation with ambient temperatures  $< -40\text{ °C}$  has an influence on the dimensions of the transition sleeve.

### Transition sleeve with the same diameter as the probe

Optionally, a transition sleeve can also be selected that has the same diameter as the metal probe. This makes it possible to slide on cable glands or compression fittings from both ends of the probe. The transition is hardly visible.

The operating limits of the transition sleeve do not change, however, i.e. it must still remain outside the process and should not be loaded with a compression fitting.

Standard diameter transition sleeve and probe

- 6 mm
- 8 mm
- 1/4 in

## Bend protection

A bend protection (spring or shrink hose) is used to protect the transition point from rigid probe to flexible connection lead. This should always be used when a relative movement between the connection lead and the thermometer mounting is expected.

For designs to Ex n or Ex e, the use of bend protection is mandatory.



Bend protection spring



Shrink hose

Both versions should be considered to be technically equivalent with respect to their function as bend protection.

## Connection cable, jacket

Cable jacket	Application range <sup>1)</sup>
PTFE	-60 ... +250 °C
PTFE, shielded (see standard versions below)	-60 ... +250 °C
Single wires, PTFE	-60 ... +250 °C
Stainless steel braid over PTFE	-60 ... +250 °C
Silicone	-50 ... +180 °C
Silicone, shielded (see standard versions below)	-50 ... +180 °C
PVC	-20 ... +100 °C
Fibreglass	-50 ... +400 °C
Stainless steel braid over fibreglass	-50 ... +400 °C
Protective metal armouring over PTFE	-60 ... +250 °C
Protective metal armouring over PFA	-50 ... +250 °C
Protective metal armouring with PTFE sheath over PTFE	-60 ... +250 °C
Protective metal armouring with PVC sheath over PVC	-20 ... +100 °C
Protective metal armouring with PE sheath over PFA	-50 ... +250 °C

### Standard cable lengths

#### Metric lengths

- 1,000 mm
- 2,000 mm
- 3,000 mm
- 5,000 mm

#### Imperial lengths

- 24 in
- 36 in
- 72 in
- 144 in

Other cable lengths are possible

### Standard versions of the shield electrical connection

- Shield not connected at the sensor, stripped lead at the end of the cable
- Shield connected at the sensor, stripped lead at the end of the cable
  
- Shield not connected at the sensor, connected at the case
- Shield connected at the sensor, connected at the case
  
- Shield not connected at the sensor, connected at the connector
- Shield connected at the sensor, connected at the connector
- Shield connected at the sensor, not connected at the connector

Other versions on request

<sup>1)</sup> Minimum/Maximum temperatures valid for stationary cable. The actual operating temperature (process temperature) of the thermometer can deviate.

## Design of the lead ends

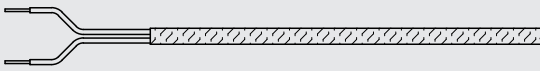
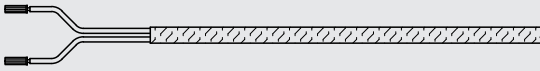
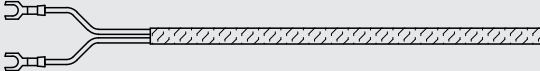
Version	Illustration
Flying leads <sup>1)</sup>	
End splices	
Spade lugs (fork design)	

## Cord grip

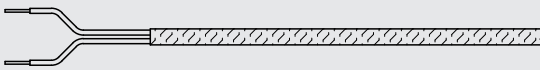
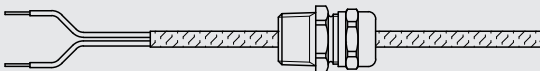
Thread size	Material	Illustration
Without	-	
M16 x 1.5	Plastic	
M20 x 1.5	Plastic	
1/2 NPT	Plastic	
1/2 NPT	Metal	
3/4 NPT	Metal	

1) Not permissible with Ex e or Ex n

## Connection housing (option)

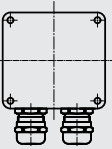
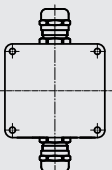

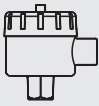
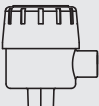
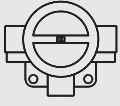
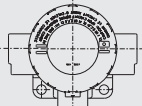
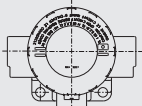

Illustration	Model	Material	Cable entry thread size	Cover	Surface	Other
	Field case	Plastic (ABS)	<ul style="list-style-type: none"> <li>■ M12 x 1.5</li> <li>■ 1/2 NPT</li> <li>■ M16 x 1.5</li> </ul>	Flat cover with 4 plug screws	Grey	<ul style="list-style-type: none"> <li>■ 82 x 80 x 55 mm (L x W x H)</li> <li>■ Inputs on one side</li> </ul>
	Field case	Aluminium	<ul style="list-style-type: none"> <li>■ M12 x 1.5</li> <li>■ 1/2 NPT</li> <li>■ M16 x 1.5</li> </ul>	Flat cover with 4 plug screws	Blank	<ul style="list-style-type: none"> <li>■ 80 x 75 x 57 mm (L x W x H)</li> <li>■ Inputs on one side</li> </ul>
	Field case	Plastic (ABS)	<ul style="list-style-type: none"> <li>■ M12 x 1.5</li> <li>■ 1/2 NPT</li> <li>■ M16 x 1.5</li> </ul>	Flat cover with 4 plug screws	Grey	<ul style="list-style-type: none"> <li>■ 82 x 80 x 55 mm (L x W x H)</li> <li>■ Inputs opposite each other</li> </ul>
	Field case	Aluminium	<ul style="list-style-type: none"> <li>■ M12 x 1.5</li> <li>■ 1/2 NPT</li> <li>■ M16 x 1.5</li> </ul>	Flat cover with 4 plug screws	Blank	<ul style="list-style-type: none"> <li>■ 80 x 75 x 57 mm (L x W x H)</li> <li>■ Inputs opposite each other</li> </ul>
	1/4000	Aluminium	<ul style="list-style-type: none"> <li>■ M20 x 1.5</li> <li>■ 1/2 NPT</li> <li>■ 3/4 NPT</li> </ul>	Screw-on lid	Blue, painted <sup>1)</sup>	-
	1/4000	Stainless steel	<ul style="list-style-type: none"> <li>■ M20 x 1.5</li> <li>■ 1/2 NPT</li> <li>■ 3/4 NPT</li> </ul>	Screw-on lid	Blank	-

Illustration	Model	Material	Cable entry thread size	Cover	Surface	Other
	7/8000	Aluminium	<ul style="list-style-type: none"> <li>■ M20 x 1.5</li> <li>■ 1/2 NPT</li> <li>■ 3/4 NPT</li> </ul>	Screw-on lid	Blue, painted <sup>1)</sup>	-
	7/8000	Stainless steel	<ul style="list-style-type: none"> <li>■ M20 x 1.5</li> <li>■ 1/2 NPT</li> <li>■ 3/4 NPT</li> </ul>	Screw-on lid	Blank	-
	7/8000	Aluminium	<ul style="list-style-type: none"> <li>■ M20 x 1.5</li> <li>■ 1/2 NPT</li> <li>■ 3/4 NPT</li> </ul>	Screw-on lid, with digital temperature display DIH50-B	Blue, painted <sup>1)</sup>	-
	7/8000	Stainless steel	<ul style="list-style-type: none"> <li>■ M20 x 1.5</li> <li>■ 1/2 NPT</li> <li>■ 3/4 NPT</li> </ul>	Screw-on lid, with digital temperature display DIH50-B	Blank	-
	5/6000	Aluminium	<ul style="list-style-type: none"> <li>■ 2 x M20 x 1.5</li> <li>■ 2 x 1/2 NPT</li> <li>■ 2 x 3/4 NPT</li> </ul>	Screw-on lid	Blue, painted <sup>1)</sup>	-
	5/6000	Stainless steel	<ul style="list-style-type: none"> <li>■ 2 x M20 x 1.5</li> <li>■ 2 x 1/2 NPT</li> <li>■ 2 x 3/4 NPT</li> </ul>	Screw-on lid	Blank	-
	5/6000	Aluminium	<ul style="list-style-type: none"> <li>■ 2 x M20 x 1.5</li> <li>■ 2 x 1/2 NPT</li> <li>■ 2 x 3/4 NPT</li> </ul>	Screw-on lid, with digital temperature display DIH50-B	Blue, painted <sup>1)</sup>	-
	5/6000	Stainless steel	<ul style="list-style-type: none"> <li>■ 2 x M20 x 1.5</li> <li>■ 2 x 1/2 NPT</li> <li>■ 2 x 3/4 NPT</li> </ul>	Screw-on lid, with digital temperature display DIH50-B	Blank	-
	Field transmitter TIF50 <sup>2)</sup>	Aluminium	<ul style="list-style-type: none"> <li>■ 2 x M20 x 1.5</li> <li>■ 2 x 1/2 NPT</li> <li>■ 2 x 3/4 NPT</li> </ul>	-	-	-
	Field transmitter TIF50 <sup>2)</sup>	Stainless steel	<ul style="list-style-type: none"> <li>■ 2 x M20 x 1.5</li> <li>■ 2 x 1/2 NPT</li> <li>■ 2 x 3/4 NPT</li> </ul>	-	-	-
	Field transmitter TIF52 <sup>2)</sup>	Aluminium	<ul style="list-style-type: none"> <li>■ 2 x M20 x 1.5</li> <li>■ 2 x 1/2 NPT</li> <li>■ 2 x 3/4 NPT</li> </ul>	-	-	-
	Field transmitter TIF52 <sup>2)</sup>	Stainless steel	<ul style="list-style-type: none"> <li>■ 2 x M20 x 1.5</li> <li>■ 2 x 1/2 NPT</li> <li>■ 2 x 3/4 NPT</li> </ul>	-	-	-
	KN4-A <sup>2)</sup>	Aluminium	<ul style="list-style-type: none"> <li>■ M20 x 1.5</li> <li>■ 1/2 NPT</li> <li>■ 3/4 NPT</li> </ul>	Screw-on lid	Blue, painted <sup>1)</sup>	-
	KN4-P <sup>2)</sup>	Polypropylene	<ul style="list-style-type: none"> <li>■ M20 x 1.5</li> <li>■ 1/2 NPT</li> <li>■ 3/4 NPT</li> </ul>	Screw-on lid	White	-
	BSZ <sup>3)</sup>	Aluminium	<ul style="list-style-type: none"> <li>■ M20 x 1.5</li> <li>■ 1/2 NPT</li> </ul>	Spherical, hinged cover with plug screw	Blue, painted <sup>1)</sup>	-
	BSZ-H <sup>3)</sup>	Aluminium	<ul style="list-style-type: none"> <li>■ M20 x 1.5</li> <li>■ 1/2 NPT</li> </ul>	High hinged cover with plug screw	Blue, painted <sup>1)</sup>	-

1) RAL 5022

2) Not permissible with Ex e or Ex n

3) Not permissible with IECEx (Ex e or Ex n) and NEPSI (Ex n)

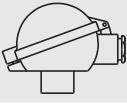
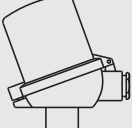
Model	Explosion protection					
	Without	Ex i (gas) Zone 0, 1, 2	Ex i (dust) Zone 20, 21, 22	Ex e (gas) Zone 1, 2	Ex t (dust) Zone 21, 22	Ex nA (gas) Zone 2
Field case, plastic (ABS)	x	-	-	-	-	-
Field case, aluminium	x	x	x	x	x	x
1/4000	x	x	x	x	x	x
7/8000	x	x	x	x	x	x
7/8000 / DIH50 <sup>2)</sup>	x	x	x	-	-	-
5/6000	x	x	x	x	x	x
TIF50	x	x	x	-	-	-
TIF52	x	x	x	-	-	-
KN4-A	x	x	-	-	-	-
KN4-P <sup>1)</sup>	x	-	-	-	-	-
BSZ	x	x	x	x <sup>3)</sup>	x <sup>3)</sup>	x <sup>3)</sup>
BSZ-H	x	x	x	x <sup>3)</sup>	x <sup>3)</sup>	x <sup>3)</sup>

1) On request



2) LC display DIH50

3) Only ATEX, no IECEx, no NEPSI

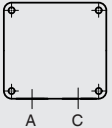
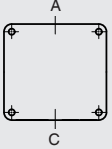
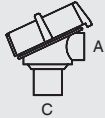
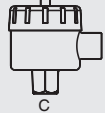
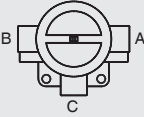
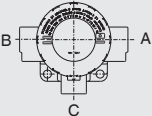

### Position of the probe input

The standard probe input is located at position C.  
 Another position for the probe input is possible as an option.

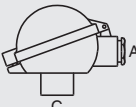
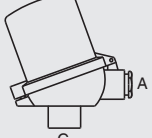
Illustration	Connection housing
	Field case with inputs on either side
	Field case with inputs on opposite sides
	Connection housing 1/4000
	Connection housing 7/8000 Connection housing 7/8000 with DIH50
	Connection housing 5/6000
	Connection housing 5/6000 with DIH50-B Field transmitter TIF50/TIF52
	Connection head KN4-A
	Connection head BSZ
	Connection head BSZ-H

## Cable entry

Cable entry	Colour	Ingress protection (max.) IEC/EN 60529 <sup>1)</sup>	Cable entry thread size	Min./max. ambient temperature
 Standard cable entry <sup>2)</sup>	Blank	IP65	■ M20 x 1.5 ■ ½ NPT	-40 ... +80 °C
 Plastic cable gland (cable Ø 6 ... 10 mm) <sup>2)</sup>	Black or grey	IP66 <sup>3)</sup>	■ M20 x 1.5 ■ ½ NPT	-40 ... +80 °C
 Plastic cable gland (cable Ø 6 ... 10 mm), Ex e <sup>2)</sup>	Light blue or black	IP66 <sup>3)</sup>	■ M20 x 1.5 ■ ½ NPT	■ -20 ... +80 °C ■ -40 ... +70 °C
 Nickel-plated brass cable gland (cable Ø 6 ... 12 mm)	Blank	IP66 <sup>3)</sup>	■ M20 x 1.5 ■ ½ NPT	-60 <sup>4)</sup> / -40 ... +80 °C
 Nickel-plated brass cable gland (cable Ø 6 ... 12 mm), Ex e	Blank	IP66 <sup>3)</sup>	■ M20 x 1.5 ■ ½ NPT	-60 <sup>4)</sup> / -40 ... +80 °C
 Stainless steel cable gland (cable Ø 7 ... 12 mm)	Blank	IP66 <sup>3)</sup>	■ M20 x 1.5 ■ ½ NPT	-60 <sup>4)</sup> / -40 ... +80 °C
 Stainless steel cable gland (cable Ø 7 ... 12 mm), Ex e	Blank	IP66 <sup>3)</sup>	■ M20 x 1.5 ■ ½ NPT	-60 <sup>4)</sup> / -40 ... +80 °C
 Plain threaded	-	IP00	■ M20 x 1.5 ■ ½ NPT	-
 2 x plain threaded <sup>5)</sup>	-	IP00	■ 2 x M20 x 1.5 ■ 2 x ½ NPT	-
 Junction box M12 x 1 (4-pin) <sup>6)</sup>	-	IP65	M20 x 1.5	-40 ... +80 °C
 Sealing plugs for shipping	Transparent	-	■ M20 x 1.5 ■ ½ NPT	-40 ... +80 °C

The figures show examples of connection heads.

1) IP ingress protection of the cable gland. The IP ingress protections of the complete instrument TR40 must not inevitably correspond to the cable gland.

2) Not available for BVS connection head

3) Ingress protections, describing temporary or permanent immersion, on request

4) Special version on request (available with selected approvals), other temperatures on request

5) Only for BSZ-H connection head

6) Not available for ½ NPT thread size cable entry

Cable entry	Explosion protection					
	Without	Ex i (gas) Zone 0, 1, 2	Ex i (dust) Zone 20, 21, 22	Ex e (gas) Zone 1, 2	Ex t (dust) Zone 21, 22	Ex nA (gas) Zone 2
Standard cable entry <sup>1)</sup>	x	x	-	-	-	-
Plastic cable gland <sup>1)</sup>	x	x	-	-	-	-
Plastic cable gland (light blue), Ex e <sup>1)</sup>	x	x	x	-	-	-
Plastic cable gland (black), Ex e <sup>1)</sup>	x	x	x	x	x	x
Brass cable gland, nickel-plated	x	x	x	-	-	-
Brass cable gland, nickel-plated, Ex e	x	x	x	x	x	x
Stainless steel cable gland	x	x	x	-	-	-
Stainless steel cable gland, Ex e	x	x	x	x	x	x
Plain threaded	x	x	x <sup>5)</sup>	x <sup>5)</sup>	x <sup>5)</sup>	x <sup>5)</sup>
2 x plain threaded <sup>2)</sup>	x	x	x <sup>5)</sup>	x <sup>5)</sup>	x <sup>5)</sup>	x <sup>5)</sup>
Junction box M12 x 1 (4-pin) <sup>3)</sup>	x	x <sup>4)</sup>	x <sup>4)</sup>	-	-	-
Sealing plugs for shipping	Not applicable, transport protection					

1) Not available for BVS connection head

2) Only for BSZ-H connection head

3) Not available for ½ NPT thread size cable entry

4) With appropriate mating connector connected

5) Suitable cable gland required for operation

## Transmitter built into the connection housing (option)

A transmitter can be mounted in an optional connection housing.

**HART**  
COMMUNICATION PROTOCOL



Output signal 4 ... 20 mA and HART® protocol		
Transmitter (selectable versions)	Model T15	Model T32
Data sheet	TE 15.01	TE 32.04
<b>Output</b>		
4 ... 20 mA	x	x
HART® protocol	-	x
<b>Connection method</b>		
1 x 2-wire, 3-wire or 4-wire	x	x
<b>Measuring current</b>	< 0.2 mA	< 0.3 mA
<b>Explosion protection</b>	Optional	Optional

For detailed specifications on the explosion protection of the transmitter, see respective transmitter data sheet.

## Accessories, connection housing

Pipe mounting kit, stainless steel (for field case)

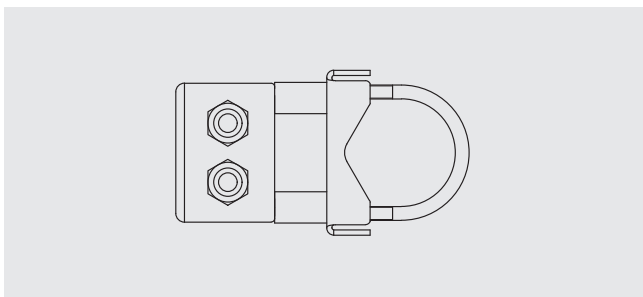

Pipe mounting kit, stainless steel (for 5/6000, DIH50/DIH52, TIF50/TIF52)

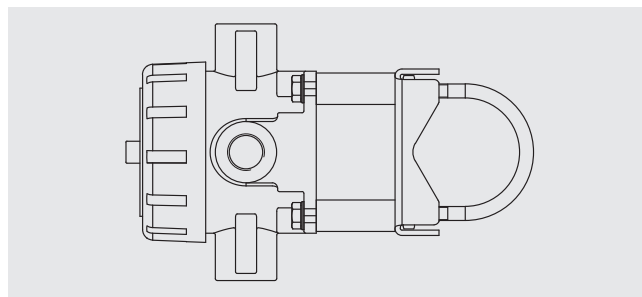

Fixing bracket (for wall mounting) 92 x 60 x 50 mm, stainless steel (for connection head models BSZ and BSZ-H)

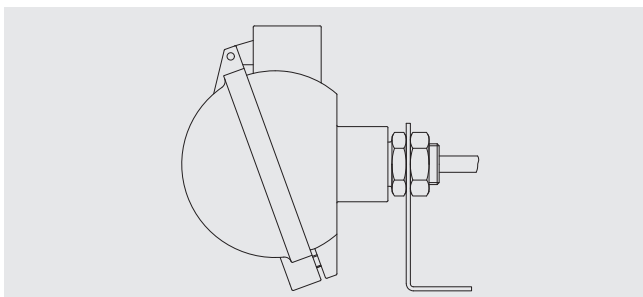

## Connector (option)

Cable resistance thermometers can be supplied with connectors fitted.

The following options are available:

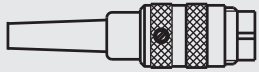
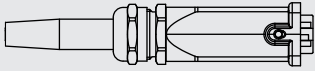
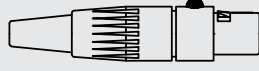
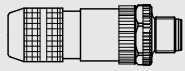
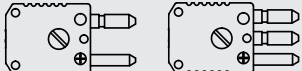
Illustration	Model
	Lemos connector (male)
	Binder/Amphenol screw/plug-in connector (male)
	Harting connector (male)
	XLR-mini connector (female)
	Binder screw/plug-in connector, M12 x 1 (male)
	Thermo-connector (male)

The figures are not to scale.

# Degrees of protection per IEC/EN 60529

## Degrees of protection against solid foreign bodies (defined by the 1st index number)

First index number	Degree of protection / Short description	Test parameters
5	Dust-protected	per IEC/EN 60529
6	Dust-tight	per IEC/EN 60529

## Degrees of protection against water (defined by the 2nd index number)

Second index number	Degree of protection / Short description	Test parameters
4	Protected against splash water	per IEC/EN 60529
5	Protected against water jets	per IEC/EN 60529
6	Protected against strong water jets	per IEC/EN 60529
7 <sup>1)</sup>	Protected against the effects of temporary immersion in water	per IEC/EN 60529
8 <sup>1)</sup>	Protected against the effects of permanent immersion in water	as agreed upon

1) Ingress protections, describing temporary or permanent immersion, on request

All data for the second index number are based on water as the test medium (IEC/EN 60529).  
Use of the instruments in other media will invalidate the guarantee/warranty.

Model TR40 is available in the following IP degrees of protection:

- IP40
- IP50
- IP54 (standard)
- IP65
- IP66
- IP67

The specified degrees of protection apply under the following conditions:

- Use of a suitable cable gland
- Use of a cable cross-section appropriate for the gland or select the appropriate cable gland for the available cable
- Adhere to the tightening torques for all threaded connections

## Classification of the IP protection zones for the probes

- Version with connection cable

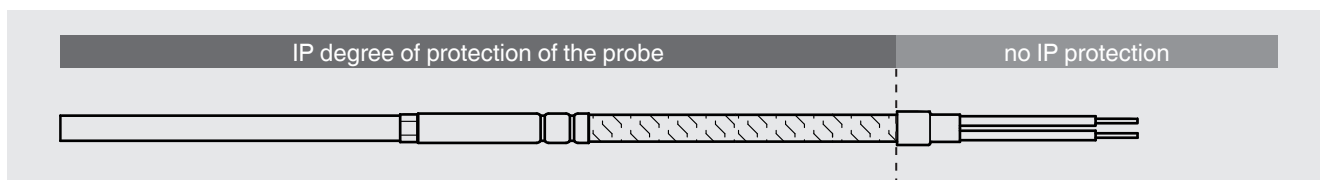

- Version with connection housing, fitted at the cable end

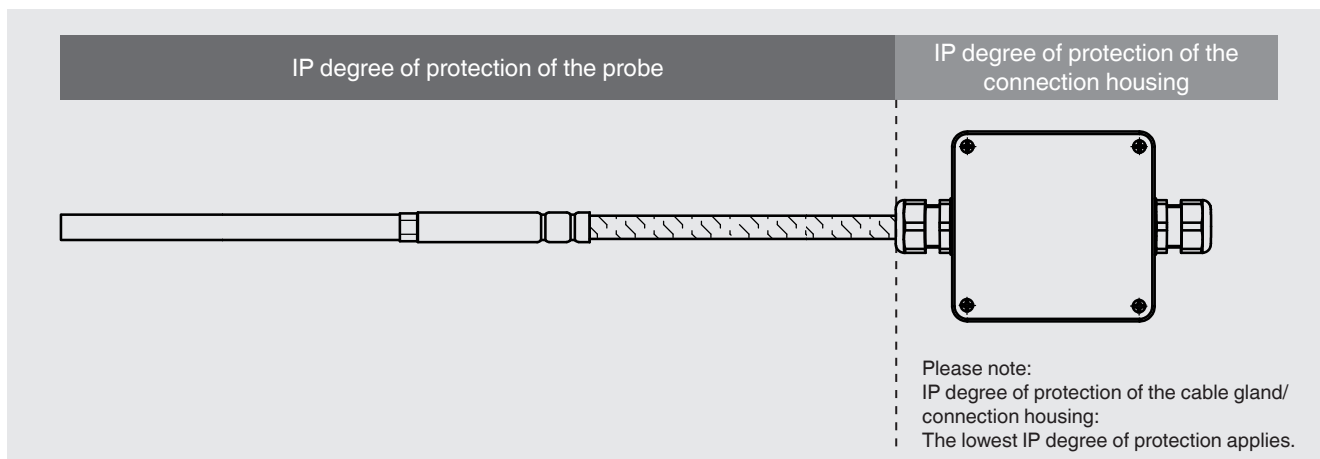

- Version with connector, fitted at the cable end

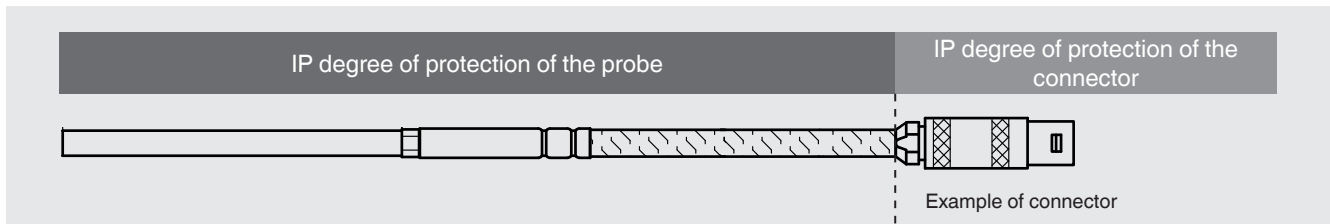

- Version with connector fitted at the MI cable

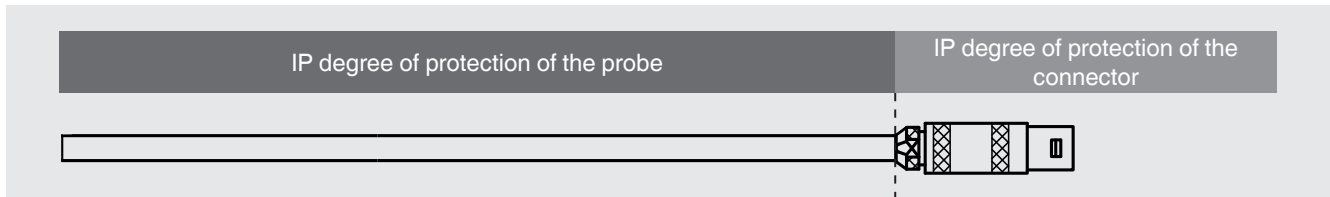

### IP ingress protection of the connection housings

Connection housing	Version	IP ingress protection
Field case	Plastic (ABS) / aluminium	IP65
Connection head	KN4-A	IP65
	KN4-P	
	BSZ	
	BSZ-H	
	1/4000	IP66
	5/6000	
	5/6000 with DIH50	
7/8000	IP66	
7/8000 with DIH50		
Field transmitter	TIF50/TIF52	IP66

### IP ingress protection types for the connector

Connector	Version	IP ingress protection
Binder	Series 680	IP40
	Series 692	
	Series 423	
Amphenol	C16-3	IP40
Lemosa	Size 0 S	IP50
	Size 1 S	
	Size 2 S	
	Size 1 E	IP65
Harting	7D	IP65
	8D	
	8U	
XLR	3-pin/4-pin, miniature	IP65
M12 x 1	4-pin	IP65
Thermo-connector	2-pin, standard/miniature	IP00
	3-pin, standard/miniature	

# Electrical connection

## Without connector

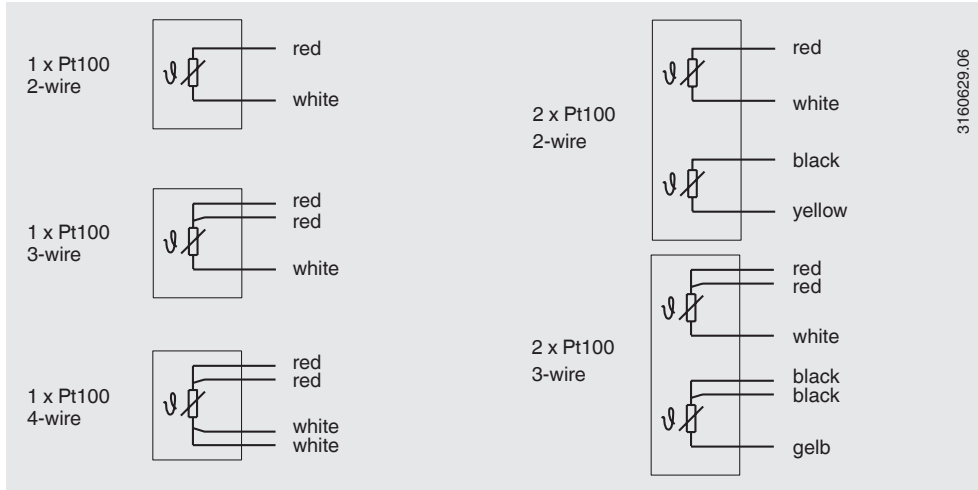

## Lemosa connector

max. permissible temperature range see page 5

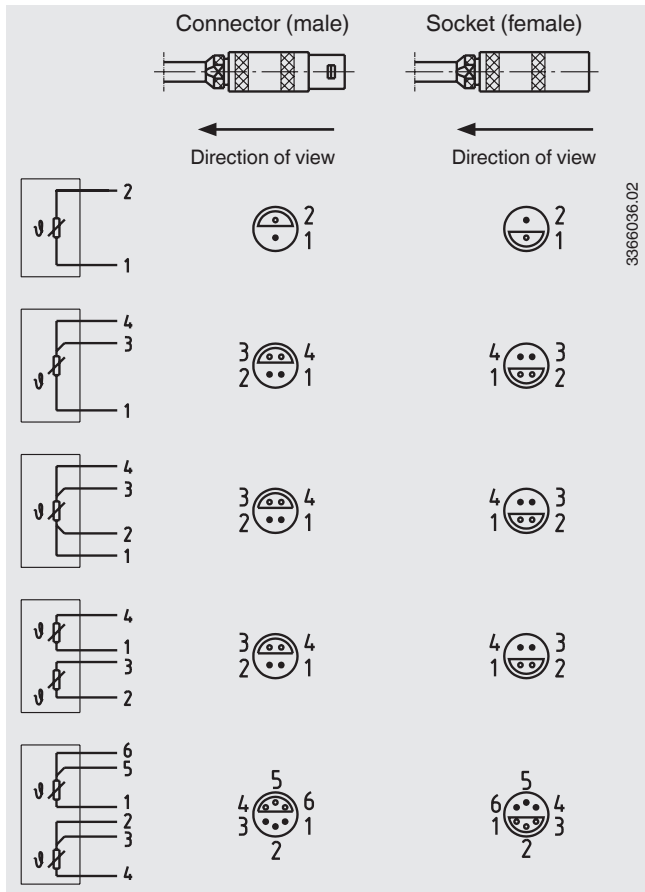

## Screw/plug-in connector (Amphenol, Binder)

max. permissible temperature range see page 5

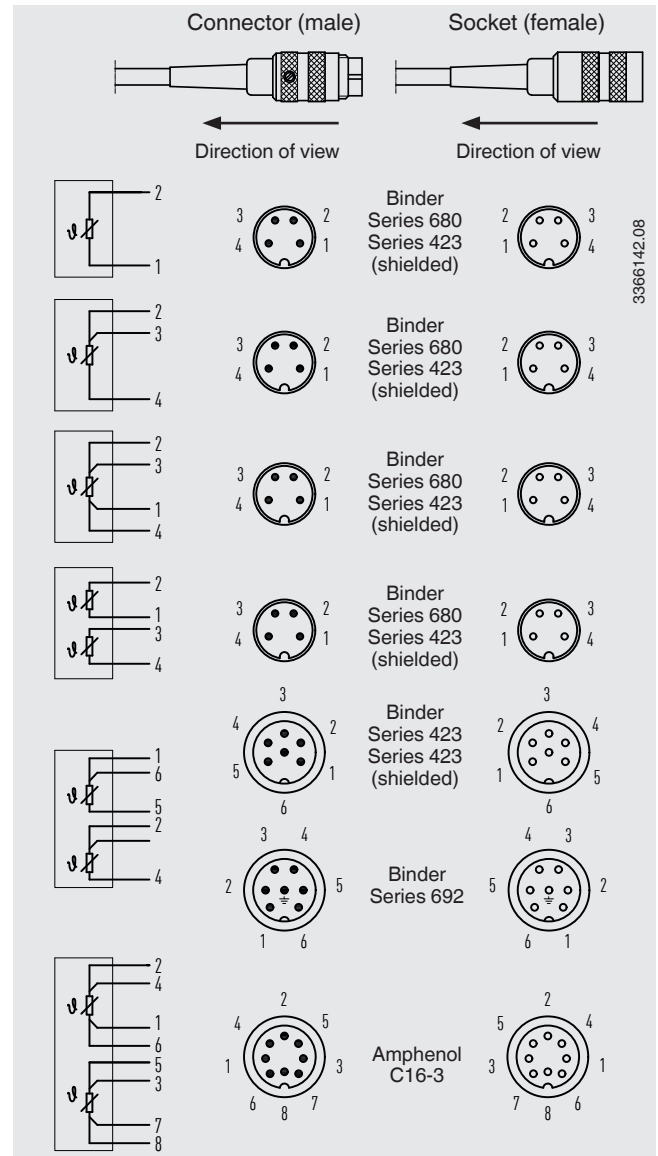



**Thermo-connector (RTD, male)**

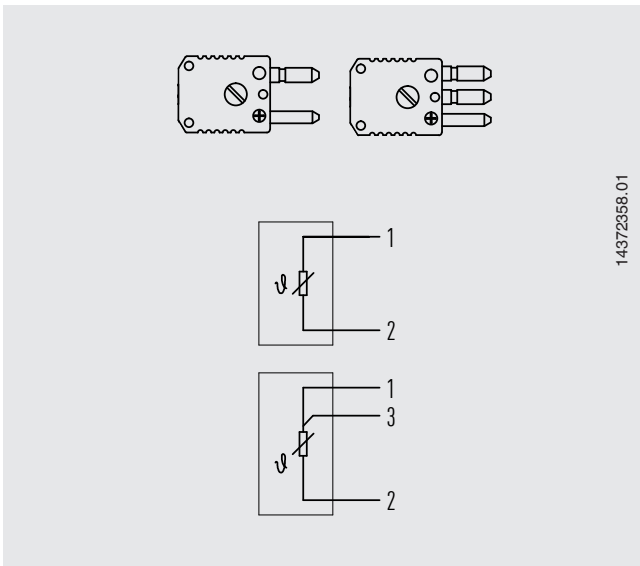

**XLR-mini connector (female)**

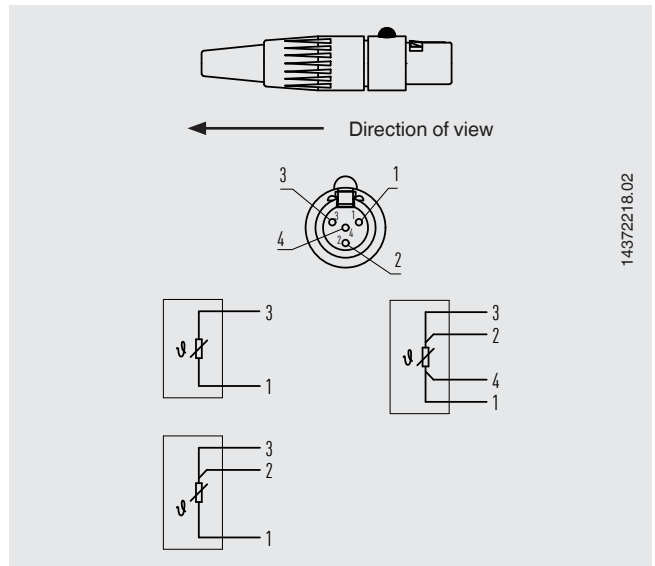

**Binder screw/plug-in connector (male), M12 x 1 (series 713)**

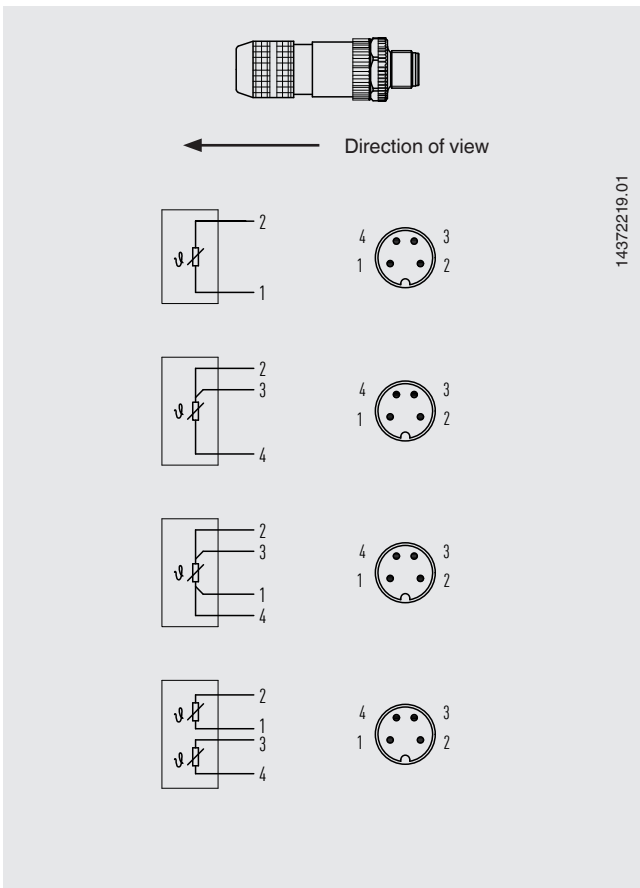

**Harting connector**

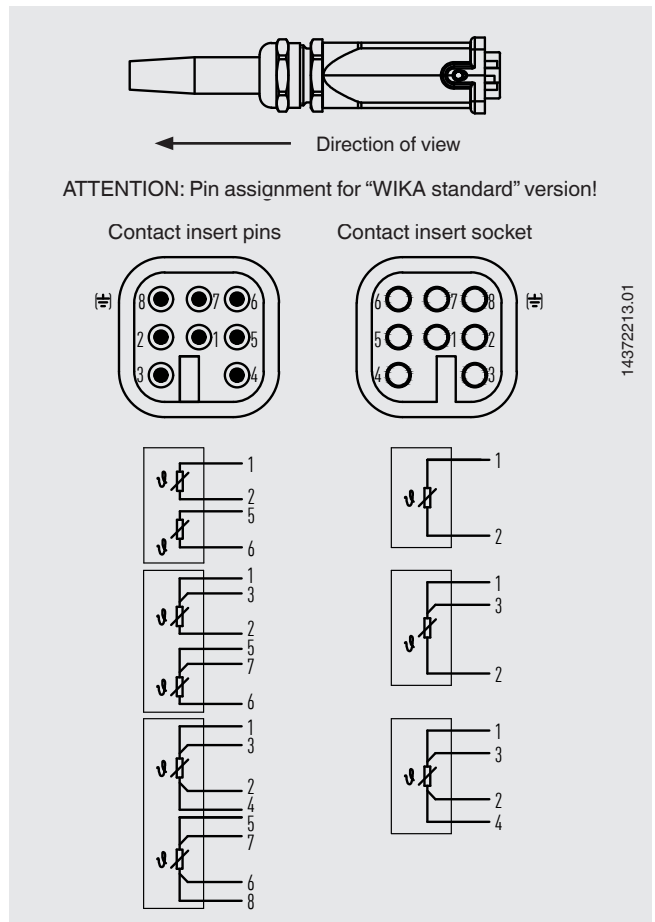

**Standard terminal block** (colour code in accordance with IEC/EN 60751)

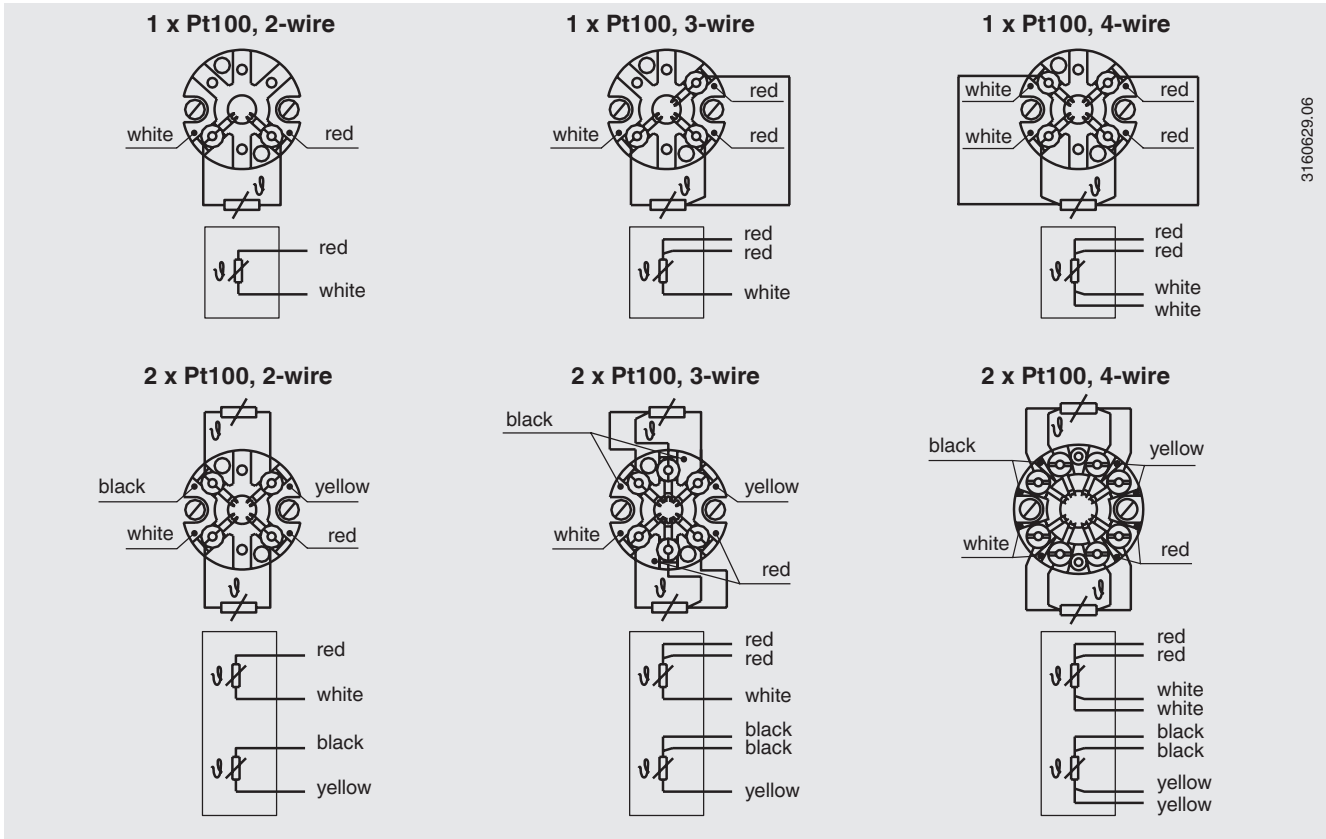

3160629.06

Assignment and colour coding for Pt1000 as for Pt100  
Pt1000 only available as single elements

**Rack-mounting terminals**

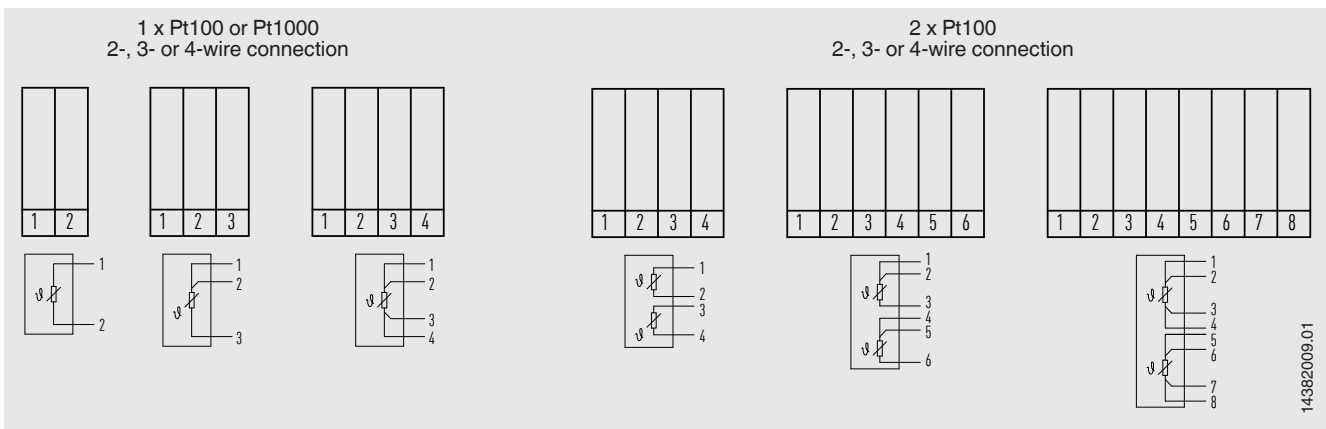

14382009.01

## Operating conditions

### Mechanical requirements

Version	
<b>Standard</b>	6 g peak-to-peak, 10 ... 500 Hz, wire-wound measuring resistor or thin film
<b>Option</b>	Vibration-resistant probe tip, max. 20 g peak-to-peak, thin-film measuring resistor
	Highly vibration-resistant probe tip, max. 50 g peak-to-peak, thin-film measuring resistor

The information on vibration resistance refers to the tip of the measuring insert.

For detailed specifications on the vibration resistance of Pt100 sensors, see Technical information IN 00.17 at [www.wika.com](http://www.wika.com).

### Storage temperature

-40 ... +80 °C

Other storage temperatures on request

## Certificates (option)

Certification type	Measurement accuracy	Material certificate
<b>2.2 test report</b>	x	x
<b>3.1 inspection certificate</b>	x	x
<b>DKD/DAkkS calibration certificate</b>	x	-

The different certifications can be combined with each other.

The minimum length (metal part of the probe or the length of the probe below the process connection) for carrying out a measurement accuracy test 3.1 or DAkkS is 100 mm [3.94 in].

Calibration of shorter lengths on request.

### Ordering information

Model / Explosion protection / Probe version / Threaded connection version / Thread size / Materials / Probe diameter / Measuring element / Connection method / Temperature range / Connection cable, jacket / Lead ends version / Certificates / Options

© 10/2008 WIKA Alexander Wiegand SE & Co. KG, all rights reserved.  
The specifications given in this document represent the state of engineering at the time of publishing.  
We reserve the right to make modifications to the specifications and materials.

## Shipping information

Model TR40 resistance thermometer in "straight" version, with lengths > 1,100 mm is wound and delivered in coils.

